

Centrifuge Modeling of Seismic Soil-Structure-Interaction and Lateral Earth Pressures for Large Near-Surface Underground Structures

Modélisation en centrifugeuse de l'Interaction sol-structure sismique et des pressions de terre latérales pour les grands ouvrages souterrains proches de la surface

Dashti S., Hushmand A., Ghayoomi M., McCartney J.S., Zhang M.
University of Colorado Boulder

Hushmand B., Mokarram N., Bastani A.
Hushmand Associates, Inc.

Davis C., Lee Y., Hu J.
Los Angeles Department of Water and Power

ABSTRACT: The Los Angeles Department of Water and Power (LADWP) is planning the construction of a new buried reservoir in Southern California. The current state of practice for evaluating the seismic response of underground structures relies heavily on simplified procedures or numerical tools that have not been verified adequately against physical model studies or detailed case histories. A series of eight centrifuge tests are currently being conducted at the University of Colorado Boulder (CU Boulder) to produce well-documented model "case histories." The data from these tests help better understand seismic soil-structure-interaction (SSI) and the distribution of lateral seismic earth pressures on the walls of a buried structure restrained at top and bottom. This paper provides a brief overview of a centrifuge physical modeling investigation into the influence of the relative stiffness of the underground structure and the characteristics of the input motion on the seismic response of buried structures.

RÉSUMÉ: Le "Los Angeles Department of Water and Power" (LADWP) prévoit la construction d'un nouveau réservoir enterré, une centrale hydroélectrique, et une station de régulation de débit en Californie du Sud. L'état actuel de la pratique d'évaluation de la réponse sismique des structures souterraines repose en grande partie sur les procédures simplifiées ou des outils numériques qui n'ont pas été comparés de manière adéquate à des modèles physiques ou des études de cas. Une série de huit essais en centrifugeuse sont actuellement en cours à l'Université du Colorado, Boulder pour produire des données complètes de prototypes. Les données de ces essais aident à mieux comprendre l'interaction sol-structure sismique et la distribution des pressions des terres latérales sismiques sur les murs d'une structure enterrée maintenue en haut et en bas. Ce document donne un aperçu d'une modélisation physique en centrifugeuse de l'influence de la rigidité relative de la structure souterraine et des caractéristiques du signal source sur la réponse sismique de la structure enterrée.

KEYWORDS: Physical modeling ; Centrifuge modeling ; Seismic soil structure interaction; Underground structures.

1 INTRODUCTION

In order to better understand the seismic response of buried water reservoirs, a series of centrifuge tests are being performed on scale-model underground structures in a new, transparent flexible shear beam (FSB) type container developed by Ghayoomi et al. (2012a,b). The data from these tests serve two important purposes: 1) to better understand seismic soil-structure-interaction (SSI) and the distribution of lateral seismic earth pressures on the walls of a buried structure restrained at top and bottom; 2) to calibrate and improve numerical models. Specifically, the goal of the tests is to provide validation data for two-dimensional (2-D) and 3-D finite element analyses of the dynamic response of equivalent model underground structures with a range of stiffnesses.

In addition to describing the testing program on buried structures, we briefly discuss the results from a preliminary centrifuge test performed on a free-field soil specimen with no structure. The goal was to initially investigate the dynamic response of uniform dry sand and simultaneously evaluate the performance of the newly designed container in simulating 1-D conditions with minimum boundary effects. The next experiments, which are currently underway, evaluate the seismic response of three different tunnel structures with varying stiffnesses and soil conditions. Accelerations, displacements, and axial strains as well as the distribution of lateral earth pressures on the restrained walls are being measured during a suite of input earthquake and sinusoidal motions in flight. The influence of the relative stiffness of the underground structure to soil and the characteristics of the input

motion (i.e., amplitude, frequency content, and duration) on the seismic response of the buried structures are being studied. The insight gained from this investigation is aimed at improving the design and safety of the Los Angeles reservoirs and similar buried water storage structures in seismically active areas.

2 RESEARCH PROGRAM

2.1 Background

In order to comply with new water quality regulations in California, the Los Angeles Department of Water and Power (LADWP) is planning to cover or bypass each of its open reservoirs and replace them with buried reinforced concrete reservoirs. The proposed buried Headworks Reservoir includes 35 to 40-foot high walls that will be buried and restrained against rotational movement at the bottom and top by the reservoir floor and roof. The current state of practice for evaluating the seismic response of underground structures relies heavily on simplified procedures or numerical tools that have not been verified adequately against physical model studies or case histories, leading to significant uncertainties. Hence, a series of dynamic centrifuge tests were planned to evaluate seismic lateral earth pressures on a range of reduced scale underground structures.

2.2 Experimental Plan

A series of eight centrifuge experiments were planned to investigate the seismic response of relatively stiff buried

structures restrained at the top and bottom in medium-dense, dry Sand, at a spin acceleration of 60g. The testing plan for the first phase of the investigation is summarized in Table 1.

Table 1. Centrifuge Testing Plan (First Phase)

Test #	Structure Model	Soil Type	Soil Relative Density (D_r)	Soil Cover on Tunnel
1	Simple Equivalent Prototype (SEP)	Nevada Sand	60%	None
2				1.5 m
3	SEP (model fixed to the container base)			None
4				1.5 m
5	Stiff SEP			None
6				1.5 m
7	Flexible SEP			None
8				1.5 m

2.2.1 Model Container

A transparent FSB-type container (Fig. 1) was developed by Ghayoomi et al. 2012a,b) to enable better visualization of the response of underground structures. The container consists of a stack of transparent, rigid frames separated by soft rubber, bonded together with high strength epoxy. The combination of rigid frames and soft rubber provides a soft and flexible lateral deflection response during 1D horizontal shaking (Divis et al. 1996). In this manner, the container does not contribute additional stiffness to the soil layer.

To characterize the response of the empty container, it was placed on a dynamic shaking table mounted on the centrifuge platform and spun up to 60g of gravitational acceleration. Next, a series of sine-sweep motions were applied to the base of the container in flight. The frequency response function of the container was calculated using the power spectral ratios of the accelerations measured using accelerometers mounted horizontally on each of the frames. The fundamental natural frequency of the empty container was 40 Hz at a centrifugal acceleration of 60g (Figure 2), confirming the soft response.



Figure 1. Picture of the transparent FSB container at CU Boulder

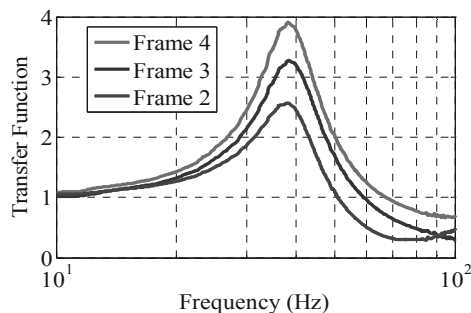

Figure 2. Frequency response of the FSB container (different acrylic frames with respect to the base) at 60g in model-scale.

2.2.2 Characterizing Soil Properties

Nevada Sand was chosen for use in the testing program, as it is a well-characterized, uniform, fine, angular sand. A relative

density (D_r) of 60% was selected for testing as it is expected to show a slight dilative response during shaking which may provide a worst-case scenario for seismic lateral earth pressures. Table 2 summarizes the properties of Nevada Sand (Ghayoomi et al. 2012a,b).

Table 2. Properties of Nevada Sand (Ghayoomi et al. 2012b)

Specific Gravity	2.65 (assumed)
Maximum Dry Unit Weight	16.39 kN/m ³
Minimum Void Ratio	0.586
Minimum Dry Unit Weight	14.00 kN/m ³
Maximum Void Ratio	0.852

2.2.3 Selection and Calibration of Ground Motions

A suite of earthquake ground motions was selected for design based on the expected seismic hazard at the project site. The selected records included scaled versions of the following motions: 1) the Izmit Earthquake recorded at the Istanbul station (far field); 2) the Northridge Earthquake recorded at the Sylmar station (near field); 3) the Loma Prieta Earthquake recorded at the LGPC station (near field). In addition to earthquake records, sine-sweeps (with amplitude = 0.3g) were selected at frequencies ranging from 0.5 Hz to 7 Hz in the prototype scale. The goal was to evaluate the response of the soil-structure system under a range of motions with different characteristics.

The “desired” ground motions were converted into “target” ground motions that are safe to use in the centrifuge by filtering out frequencies that are beyond the capability of the shake table and are potentially damaging to the centrifuge (e.g., Mason et al. 2010). In this case, frequencies less than 0.1 Hz and greater than 15 Hz were filtered using an eighth-order band-pass Butterworth filter. The target motions were converted to model scale units for both time and acceleration values (e.g., accelerations multiplied by 60 and time values divided by 60), to convert the “target” motion to the “command” signal.

The “achieved” motion by the shake table may not be the same as the “command” motion because of the nonlinear response of the overall system. The shake table tends to damp out the higher frequency signals and amplify the lower frequencies. A frequency-domain transfer function was applied to the “command” signal iteratively in order to better match the “achieved” motion with the “target”. Particular attention was given to the Arias-Intensity time history of the “target” motion, roughly quantifying the energy of the ground motion as well as the 5%-damped spectral accelerations. Figure 3 compares an example of “achieved” and “target” base motions during the Northridge event with a scaled prototype PGA of 0.3g.

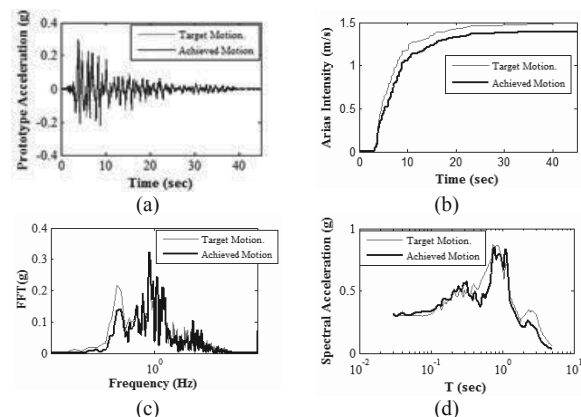

Figure 3. Comparison of the “achieved” and “target” motions during the Northridge event (scaled PGA = 0.3g) in prototype scale.

2.2.4 Design of Equivalent Model Underground Structures

Three simple equivalent model underground structures were designed and constructed (e.g., Figure 4), to simulate prototype

structures with a range of expected dynamic properties (e.g., mass and stiffness). The first mode frequency of each structural model was measured in a 1-g shaking table test as shown in Figure 5a. The frequency values were in good agreement with the numerical estimates obtained using SAP and Abaqus. The quality of the weld between the walls of models was observed to be a key parameter in obtaining a good match between numerical and experimental values of the resonant frequencies.

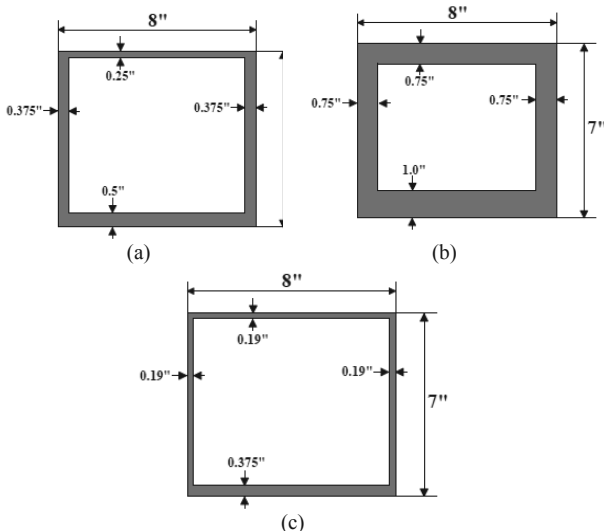

Figure 4. Dimensions of three model structures in model scale: (a) SEP Structure; (b) Stiff SEP; (c) Flexible SEP.

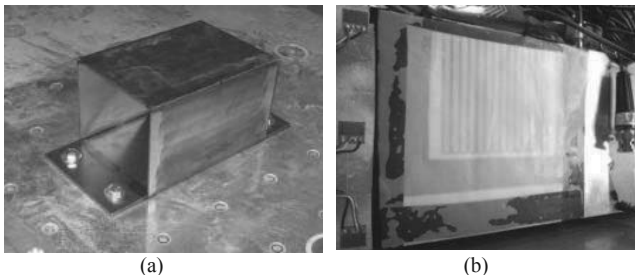

Figure 5. Baseline structure: a) 1-g shake table testing; b) Tekscan pressure sensor placement on the tunnel wall.

2.2.5 Instrumentation Challenges

Horizontal LVDTs were mounted on a rack attached to the stationary centrifuge platform and the light-weight cores were attached to the container frames. Vertical LVDTs were attached to a rack mounted on the top of the container. Permanent racking displacement of the tunnel structures was assumed to be small due to the high stiffness of these models. Hence, accelerometers were judged to provide a reasonable means for estimating transient racking deformations for each underground structure. Visual monitoring of the structures through the transparent walls of the container provides another means for the verification of racking behavior during shaking.

Tactile pressure sensors from Tekscan, Inc. were used in this study to measure dynamic earth pressures. They are flexible, thin sheets capable of measuring normal stresses applied with a matrix of sensels. This flexible sensor permits measurement of 2-D stress distributions on a surface with minimum deflection. Previous commercially-available tactile sensors were not reliable in capturing the full amplitude content of dynamic signals under the high-frequency environment of the centrifuge. This is in part due to signal aliasing and the sensor's own frequency response (filtering effect). The sensor model used in this study (9500) has a sampling rate up to 4,000 Hz, which is rapid enough to avoid signal aliasing. The frequency response of each sensors was then characterized in dynamic tests using a load frame (Dashti et al. 2012). The frequency response of these sensors was used as a transfer function to

recover the original pressure time histories. The response and accuracy of these tactile pressure sensors are affected by the presence of shear (Palmer et al. 2009). Shear was minimized by incorporating a Teflon-Teflon interface between the sensor and soil (Figure 5b) as recommended by Palmer et al. (2009)

3 PRELIMINARY FREE-FIELD TEST

A free-field soil model (with no structure) was prepared and tested at 60g of spin acceleration, as the baseline experiment to investigate the dynamic response of dry Nevada Sand and the performance of the container when filled with sand.

3.1 Test Setup and Instrumentation

A layer of Nevada sand with a relative density of 60% was prepared by dry pluviation in the FSB container. The sand was placed atop a 5 mm-thick layer of gravel, which is intended to provide a no-slip boundary at the base of the soil profile. The dimensions of the sand specimen were: 700 mm long, 305 mm wide, and 336 mm high in the model scale. The instrumentation layout within the sand layer, including LVDTs and accelerometers, is shown in Figure 6.

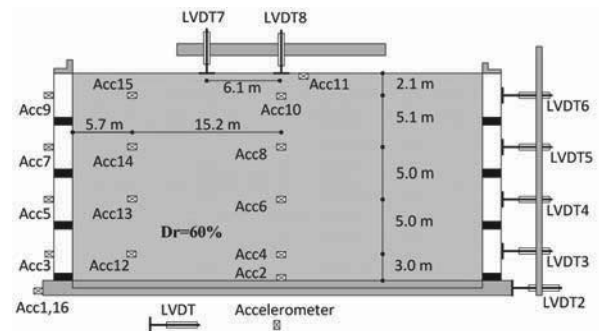

Figure 6: Instrumentation layout in preliminary free-field test (dimensions in prototype scale).

3.2 Test Results

Figure 7 presents an example array of acceleration recordings within the soil column and a comparison of Arias Intensity-time histories recorded by the accelerometers in the center of the soil profile and near the boundary of the container. The comparisons show little difference between the two arrays, indicating minimum boundary effects in this container. The recorded settlement time histories at two locations were also consistent. The settlement measurements indicated little densification during the application of sine-sweeps, and considerable densification during each broad-band earthquake motion. Hence, the change in soil relative densities after each event must be incorporated into the numerical models.

4 CENTRIFUGE TESTING OF SOIL-STRUCTURE SYSTEM

4.1 Test Setup and Instrumentation

A preliminary test on a trial flexible SEP model structure was performed to evaluate the proposed model instrumentation and response. The model was instrumented with accelerometers, LVDTs, strain gauges, and pressure transducers as shown in Figure 8. Accelerometers were placed away from, adjacent to, and on the structure to evaluate soil-structure-interaction effects. LVDTs were used to measure settlements at key locations. Strain gauges were placed on both walls to measure moment distributions and to indirectly calculate dynamic earth pressures.

4.2 Test Results

Table 3 summarizes the sequence and PGA's of the achieved base motions during Test 1. Figure 9 compares the acceleration

records at the same elevation on the structure and in the free-field during the Izmit event, showing an amplification of movement near on the roof of the structure.

Figure 10 presents the recorded settlements at various locations with respect to the structure, showing larger settlements in the free-field, which decreased towards the structure. This settlement pattern was expected due to the smaller weight of the tunnel compared to the adjacent soil. A larger settlement of the surrounding soil compared to the tunnel led to an overall decrease in permanent lateral earth pressures on the walls after each shaking event. These results are currently being studied in combination with strain distributions and direct pressure measurements for different underground structures and base motions for Test 1 and the subsequent tests.

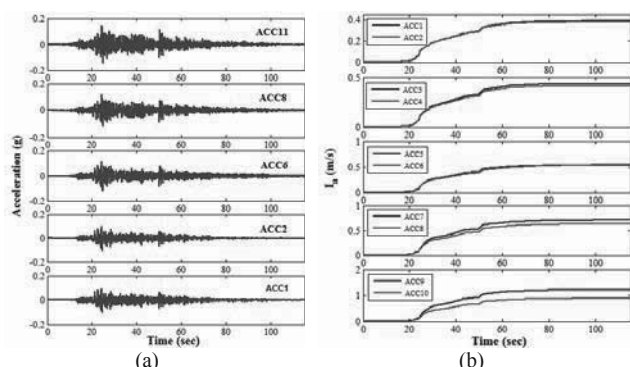

Figure 7: Measured acceleration recordings in the free-field test compared in the middle and near the container boundary.

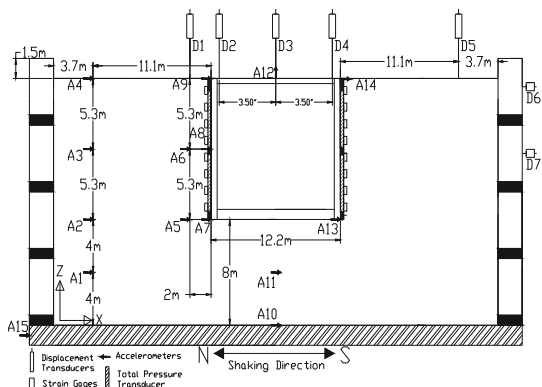

Figure 8. Instrumentation layout in Test-1 (prototype scale)

Table 3. Achieved Motions in Test-1

No.	Ground Motion	Achieved PGA
1	Izmit - Istanbul	0.3
2	Northridge - Sylmar	0.3
3	Northridge - Sylmar	0.8
4	Northridge - Sylmar	1.1
5	Loma - LGPC	1.0

5 CONCLUSION

Dynamic centrifuge experiments were conducted on scale-model buried reinforced concrete water reservoirs currently being designed in southern California. The goal of testing was to verify 2-D and 3-D numerical models of equivalent underground structures restrained at the top and bottom. The data from these experiments will help evaluate the effects of seismic soil-structure-interaction (SSI) on the distribution of accelerations and lateral earth pressures on underground structures with different stiffnesses, soil conditions, and input ground motion characteristics. This paper includes a discussion of the centrifuge testing plan for evaluating the seismic response of buried structures, including the container characterization,

development of scale model structures, instrumentation challenges and preliminary results.

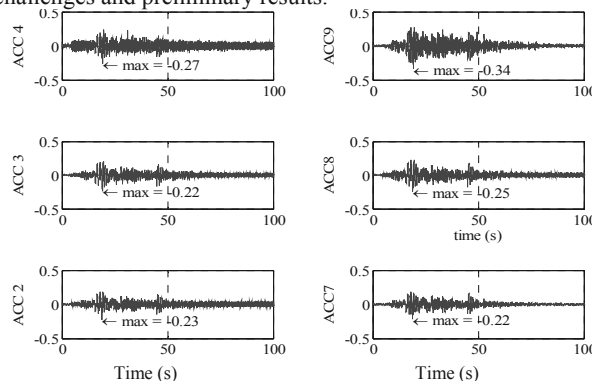

Figure 9. Acceleration time histories (in prototype "g") recorded in the free-field and on the structure during the Izmit event in Test-1.

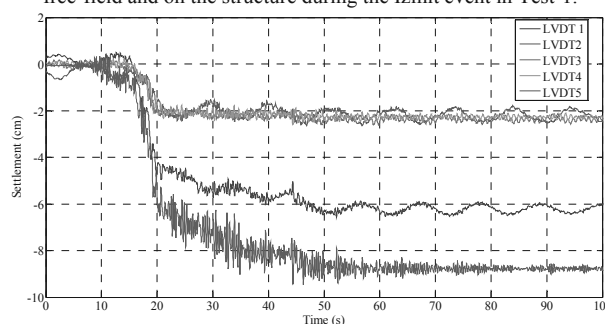

Figure 10. Settlement recorded at various locations with respect to the structure in Test-1 during the Izmit event.

6 ACKNOWLEDGEMENTS

The authors would like to thank the Los Angeles Department of Water and Power for the financial support of this project and the centrifuge facility staff at the University of Colorado Boulder.

7 REFERENCES

Dashti, S., Gillis, K., Ghayoomi, M., and Hashash, Y. (2012). "Sensing of Lateral Seismic Earth Pressures in Geotechnical Centrifuge Modeling," *15th World Conf. on EQ Eng.*, Lisbon.

Divis, C.J., Kutter, B.L., Idriss, I.M., Goto, Y., and Matsuda, T. (1996). "Uniformity of Specimen and Response of Liquefiable Sand Model in Large Centrifuge Shaker," *6th Japan-US Workshop on Earthquake Resistant Design of Lifeline Facilities and Countermeasures against Soil Liq.* pp. 259-274.

Ghayoomi, M., Dashti, S., McCartney, J.S. (2012a). "Performance of a Transparent, Flexible Shear Beam-Type Container in Dynamic Centrifuge Modeling of Geotechnical Systems," *J. of Soil Dyn. and EQ Eng.* (under review).

Ghayoomi, M., Dashti, S., McCartney, J.S. (2012b). "Effect of Boundary Conditions on the Performance of a Transparent Flexible Shear Beam-Type Container," *2nd Int. Conf. on Perf.-Based Design EQ Geotech. Eng.*, Taormina, Italy.

Palmer, M.C., O'Rourke, T.D., Olson, N.A., Abdoun, T., Ha, D., O'Rourke, M.J. (2009). "Tactile Pressure Sensors for Soil-Structure Interaction Assessment." *J. of Geotech. and Geotech. Eng.*, ASCE, 1638-1645

Mason, H.B., Bray, J.D., Kutter, B.L., Wilson, D.W., and Choy, B.Y. (2010). "Earthquake motion selection and calibration for use in a geotechnical centrifuge." *7th Int. Conf. on Physical Modeling in Geotechnics*. Zurich, Switzerland.