

Finite Element Modelling of Construction Processes of The Modular Approached Tunnelling Method

Modélisation par éléments finis du processus de construction de la méthode tunnel modulare

Komiya K.
Chiba Institute of Technology, Narashino, Japan

ABSTRACT: A modular approached tunnelling method is a new mechanized tunnelling method which has been developed to construct large scale tunnels under-crossing the existing railroad tracks or other existing main artery traffics in urban areas. In the method, a lining frame is first formed in a soil ground by with step-by-step excavation using a small tunnel boring machine and insertion of a box-module. After completion of the lining frame, the soil within the internal section of the lining frame is excavated. In this paper, the advancement and excavation processes of the box-modules operations were modelled using the finite element method in order to investigate the effect of these construction processes on the ground response. The proposed modelling techniques were applied to simulate a modular approached tunnelling work in soft cohesive soil in Tokyo and the results were compared with the field measurements.

RÉSUMÉ : Une méthode modulaire approché tunnel est une méthode nouvelle tunnel mécanisé qui a été développée pour construire des tunnels à grande échelle sous-franchissement des voies ferrées existantes ou d'autres trafics existants artères principales dans les zones urbaines. Dans le procédé, un premier cadre de revêtement est formé dans un motif en sol à l'étape par étape à l'aide d'une machine d'excavation du tunnel petite forage et l'insertion d'une boîte module. Après l'achèvement de la trame de revêtement, le sol à l'intérieur de la section interne du cadre d'habillage est excavé. Dans cet article, les processus d'avancement et l'excavation des opérations box-modules ont été modélisés à l'aide de la méthode des éléments finis afin d'étudier l'effet de ces processus de construction sur la réponse du sol. Les techniques de modélisation proposées ont été appliquées pour simuler un travail modulaire, s'approcha de tunnel dans un sol cohérent doux à Tokyo et les résultats ont été comparés avec les mesures sur le terrain.

KEYWORDS: modular approached tunnelling method, finite element method, construction process, displacement, soft clay.

1 INTRODUCTION

A modular approached tunnelling method (Nozawa S. 2003) is a new mechanized tunnelling method which has been developed to construct large scale tunnels under-crossing the existing railroad tracks or other existing main artery traffics in urban areas.

In the method, a lining frame is first formed in a soil ground by with step-by-step excavation using a small tunnel boring machine and insertion of a box-module as shown in Figure 1. After completion of the lining frame, the soil within the internal section of the lining frame is excavated.

As the excavation by the tunnel boring machine is of small scale and guided by the existing adjacent box-module, it is possible to perform safe construction even where the overburden is small. Therefore, as the modular approached tunnelling method has a variable for a large cross section with extremely shallow overburden earth coverage, the method has been used extensively for the construction of road tunnels under the existing rail track.

Since many advances such as the development of new excavation machines have been made in order to optimise the modular approached tunnelling method, the magnitude of soil deformation has become small. However even with recent advancements of the method, the tunnelling in soft clayey ground, where the SPT-N value is close to zero, is still a major technical challenge to engineers.

In this paper, the advancement and excavation processes of the tunnel boring machine and the box-module are newly modelled using the finite element method in order to investigate the effect of the step-by-step construction processes on the ground response. The proposed modelling techniques are applied to

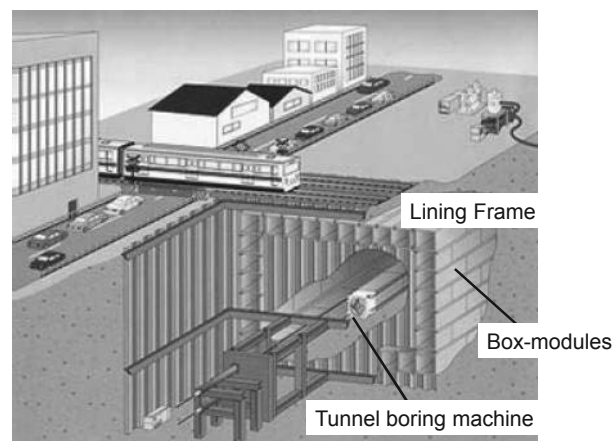

Figure 1. Overview of the modular approached tunnelling.

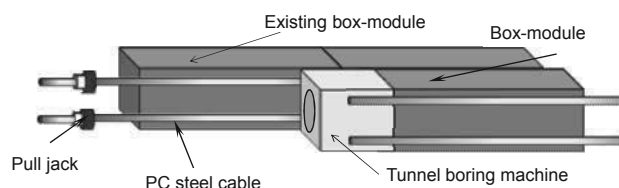

Figure 2. Construction process of box-module.

simulate a modular approached tunnelling work in Tokyo and the numerical results are compared with the field measurements.

2 FINITE ELEMENT MODELLING OF EXCAVATION AND ADVANCEMENT OF THE BOX-MODULES

Figure 2 shows the excavation and insertion processes of box-jacking operation in the modular approached tunnelling method, forward by applying mechanical pull jack forces and excavating the tunnel boring machine and the box-module are driven the soil in front of the tunnel boring machine with its cutting face. The magnitude and distribution of the ground deformations are largely controlled by the construction processes of each box-jacking. Therefore, when estimating the ground deformation caused by the modular approached tunnel construction, care should be taken of how to model the characteristics of the machine and the construction processes.

Because of the complex boundary conditions of a box-jacking tunnelling problem, the use of the finite element method is one of the useful methods to investigate the ground deformation behaviour. In reality, the stress-strain state of the soil changes continuously as the tunnel boring machine and the box-module advances. Then, in order to fully understand the ground deformation mechanism associated with box-jacking, the deformation caused by excavation and insertion processes of the box-module needs to be investigated.

In this study, the excavation process is modelled by introducing excavating finite elements in front of the tunnel boring machine (Komiya K. et.,al. 1999). The advancement of the tunnel boring machine is modelled by (i) remeshing the finite elements at each time step, (ii) introducing the excavating finite elements of a fixed size in front of the tunnel boring machine, and (iii) applying external forces for the advancement of the machine and box-module. Sequential illustrations of the modelling of the excavation at the cutting face of the tunnel boring machine (TBM) and the advancement of the machine and box-module are shown in Figure 3.

Figure 3(a) shows the status of the tunnel boring machine and box-module at reference time t_0 . In order to model the external pull forces applied to the tunnel boring machine, forces are applied at the nodes of the tunnel boring machine. During the time interval of t_0 to t_0+dt , the excavating elements and the soil elements adjacent to the tunnel boring machine elements will deform by the external force (Figure 3(b)). The tunnel boring machine will act as rigid bodies since a large value of stiffness is used for the elements representing the tunnel boring machine.

After obtaining a solution for $t = t_0+dt$, the finite elements are remeshed as shown in Figure 3(c). The new mesh will have the same mesh geometry relative to the tunnel boring machine as

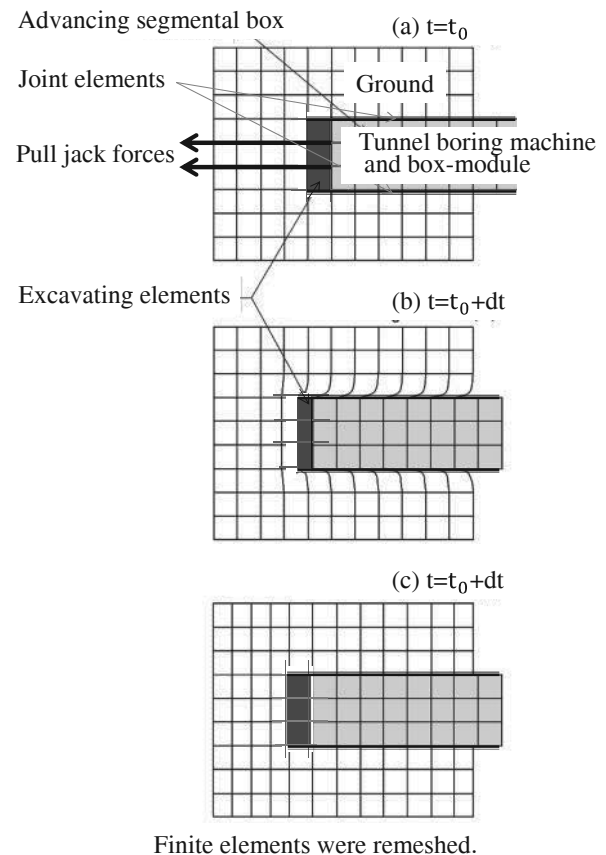

Figure 3. Advance of the box-module simulated by using the excavating elements.

$t = t_0$, but the location of the tunnel boring machine and box-module has shifted. Again, the excavating elements will be placed in front of the cutting face before applying external forces given for the next time step. By doing so, the construction processes of the box-module and the associated stress-strain changes of the ground are numerically simulated in a continuous manner.

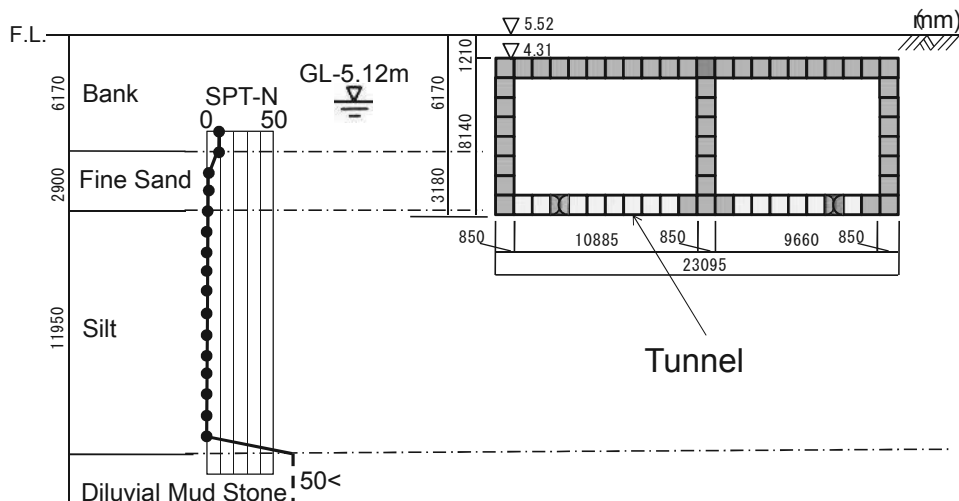

Figure 4. The formation of the box-modules (lining frame) and the site stratigraphy on the cross section.

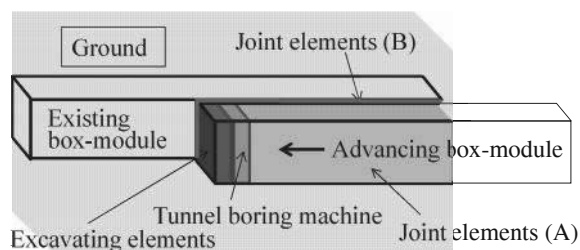

Figure 5. Arrangement of joint elements.

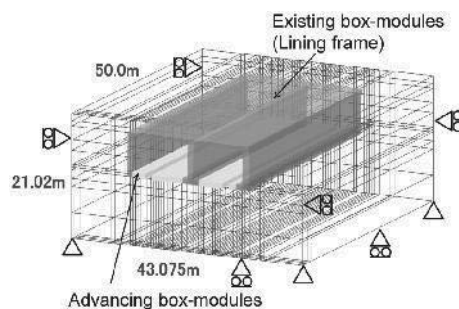

Figure 6. Three dimensional finite element model.

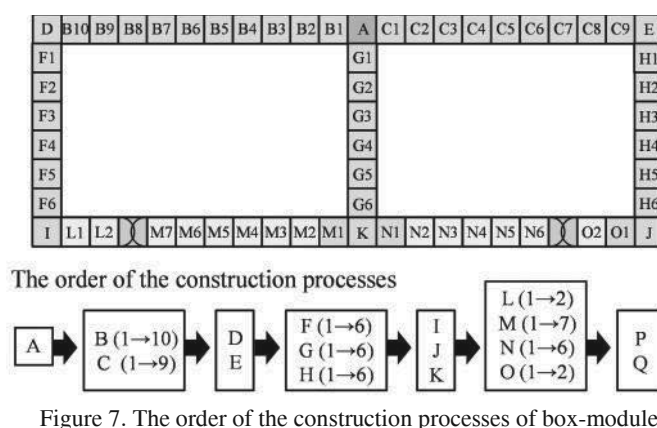

Figure 7. The order of the construction processes of box-module.

3 FINITE ELEMENT SIMULATION OF THE MODULAR APPROACHED TUNNELLING WORK

A three dimensional finite element analyses were conducted to simulate the construction process of the wall structure of a modular approached tunnelling work in Japan. The sixty rectangular box-modules of 0.85 m width, 0.85 m height and 30.0 m long were inserted in order to build the lining frame. These box-modules were integrated finally to the lining frame in approximately 23.10 m width and of 8.14 m height with earth coverage of only 1.20 m underneath major rail tracks as shown in Figure 4. The site stratigraphy determined from borehole logs is also shown in Figure 4.

In this study, for convenience, the isotropic elastic model was used to model the stress-strain behaviour of the soil, the tunnel boring machine and the box-modules. Most of the input parameters were determined from the results provided by standard geotechnical tests on samples obtained at various depths. Other input parameters, which were not able to be determined from these tests, were assessed by the results of the in-situ geotechnical tests. Summary descriptions of the soil divisions and input parameters based on the examination of site samples were given below:

- (1) Bank-soil : $E=5600 \text{ kN/m}^2$, $\nu=0.333$, $\rho=1.735 \text{ g/cm}^3$
- (2) Fine sand : $E=5600 \text{ kN/m}^2$, $\nu=0.333$, $\rho=1.786 \text{ g/cm}^3$
- (3) Silt : $E=1000 \text{ kN/m}^2$, $\nu=0.444$, $\rho=1.531 \text{ g/cm}^3$
- (4) TBM and advancing box-module : $E=4.7 \times 10^5 \text{ kN/m}^2$, $\nu=0.300$, $\rho=1.786 \text{ g/cm}^3$
- (5) Existing box-module (lining frame): $E=4.7 \times 10^7 \text{ kN/m}^2$, $\nu=0.290$, $\rho=2.300 \text{ g/cm}^3$
- (6) Excavating elements : $E=300 \text{ kN/m}^2$, $\nu=0.100$, $\rho=2.300 \text{ g/cm}^3$

where E is Young's modulus, ν is Poisson's ratio and ρ is bulk density.

Since the box-module was filled with mortar after completion of advancement, the properties were different between the existing box-modules (lining frame) and the advancing box-

module. For the excavating elements, a Young's modulus of 300 kN/m^2 , Poisson's ratio of 0.1 and the thickness of 1 m were selected.

Goodman type joint elements (Goodman R.E., et al, 1968) were placed at the interface (A) between the soil and the box-module and (B) between the existing box-module and the advancing box-module, in order to investigate inter-face frictional effects on ground deformation as shown in Figure 5. The frictional resistance stiffness of the joint elements (A) and (B) are 100 and 200 kN/m respectively and the normal stiffness of the (A) and (B) are 5.0×10^5 and $1.0 \times 10^6 \text{ kN/m}$ respectively.

The measured pull jacking forces were applied as nodal forces in front of the tunnel boring machine.

Figure 6 shows three dimensional finite element model using the analyses. Figure 7 shows the order of the box-module construction. The box-modules (B, C, D, E) at the top part of the lining frame were first constructed, and then the box-modules (F, G, H, I, J, K and M1, N1, O1) at the vertical wall of the lining frame were constructed, after which the box-modules (L, M, N, O) at the invert were constructed. The order of the advancing of box-module in the invert section was $[N2 \text{ and } L1] \rightarrow N3 \rightarrow [M2 \text{ and } L2] \rightarrow [M3 \text{ and } N4] \rightarrow [M4 \text{ and } N5] \rightarrow M5 \rightarrow [M6 \text{ and } N6] \rightarrow M7 \rightarrow O2$. Braces [] indicates that two box-modules were advanced simultaneously.

During constructing the box-modules of the invert part of the lining frame, the contractor measured vertical displacements of the existing top part of the lining frame at (already integrated) B10, B5, A, C5 and C9 (see Figure 8) until the box-modules M6 and N6 were completely advanced.

Figure 9 and Figure 10 show the measured and the calculated vertical settlement trough on the top part of the existing lining frame at the end of the tunnel during the advancement of the invert box-modules (L, M, N, O) respectively. The measured and computed vertical displacement at the end of the box-module A is plotted against the order of the box-module constructions in Figure 11. Although the calculated value demonstrated an increase in vertical displacement during initial

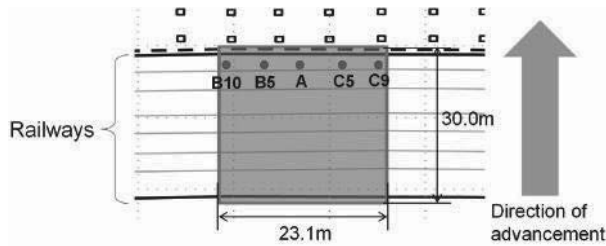

Figure 8. Location of the measurement points.

advancement of box-modules L1, L2 and L3, both the calculated and measured vertical displacements are almost identical after the insertion of the L3.

4 CONCLUSIONS

In this paper, the advancement and excavation processes of the new modular approached tunnelling method were modelled using the finite element method in order to investigate the effect of these construction processes on the ground response. The excavating finite element introduced in front of the cutting face of the tunnel boring machine, and the operation of box-module advancement and of soil excavation was simulated using the finite element remeshing technique at each time step of the analysis. The proposed modelling techniques were applied to simulate a modular approached tunnelling work in soft ground in Tokyo and the results were compared with the field measurements.

The vertical displacement profiles of the lining frame were obtained from the three-dimensional finite element simulation using the proposed modelling technique for nine insert sections of the box-module.

The shape of the computed settlement trough at the top of the lining frame was similar to the measured results. Although the calculated magnitude of vertical displacement was larger than those in the first two insert sections, both the calculated and measured vertical displacements of the lining frame were almost identical after the third insert section of the box-module.

5 REFERENCES

Goodman, R.E., et al. (1968) A Model for the Mechanics of Jointed Rock, Proc. ASCE, Vol.94, No.SM3, pp.637-659
 Nozawa, S. 2003. Reduction of the cost of construction in the space above and below rails, *JR EAST Technical Review*, East Japan Railway Company, 4, 23-28.
 K. Komiya, et al. 1999. Finite element modelling of excavation and advancement processes of a shield tunnelling machine, *Soils and Foundations*, Japanese Geotechnical Society, 39(4), 37-52.

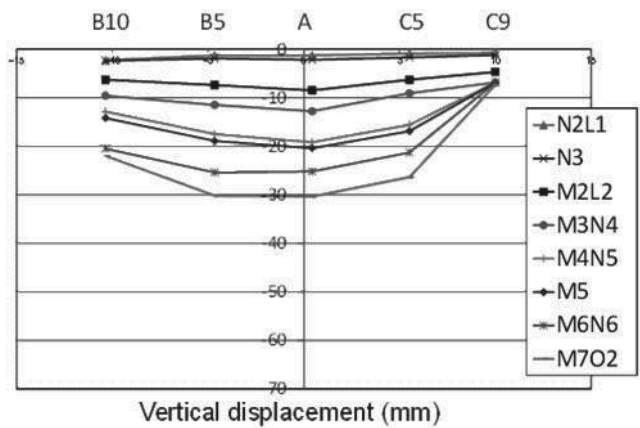

Figure 9. Measured vertical settlement trough on the top part of the existing lining frame.

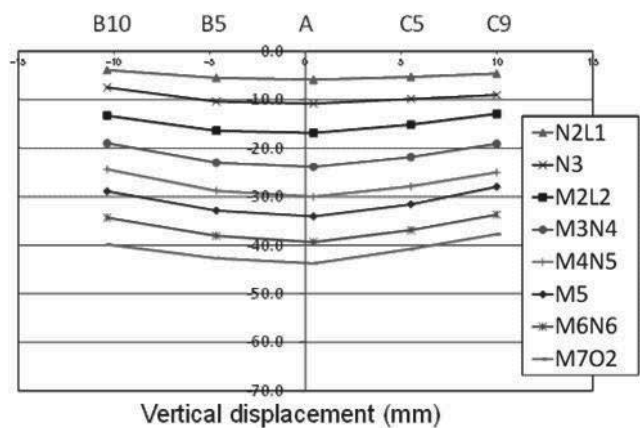

Figure 10. Calculated vertical settlement trough on the top part of the existing lining frame.

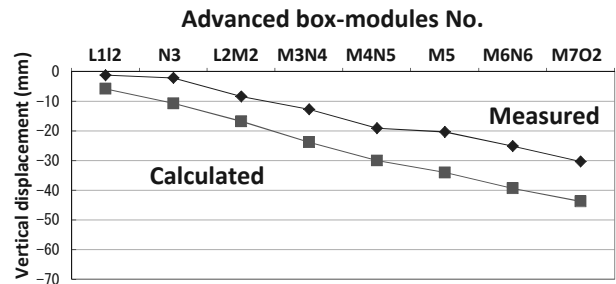

Figure 11. Vertical displacement against the order of the box-module constructions.