

Construction of a Cross Passage between Two MRT Tunnels

Construction d'un passage entre deux tunnels de MRT

Fang Y.S., Lin C.T., Liu C.

Department of Civil Engineering, National Chiao Tung University, Hsinchu, Taiwan

Cheng K.H.

Department of Rapid Transit Systems, Taipei City Government, Taipei, Taiwan

Su C.S., Chen T.J.

Railway Department II, Sinotech Engineering Consultants, Ltd., Taipei, Taiwan

ABSTRACT: This paper reports the ground improvement and excavation of a cross passage between two shield tunnels for the construction of Tu-chen Line of Taipei Rapid Transit Systems. Jet grouting was conducted for soils around the cross passage before the tunneling with the shield machine. Water-leak tests were conducted to detect any possible crack in the JSG soilcrete, and chemical grouting was conducted from the shield tunnel to fill any possible crack. It is concluded that the subsurface conditions encountered at great depths might be quite complicated. The geotechnical engineer should never overestimate the watertight characteristics of the soilcrete formed around the cross passage by jet grouting and chemical grouting. Under the threat of high water pressure, the contractor is suggested to bear the multiple-defense-lines concept to keep the excavation work on the safe side.

RÉSUMÉ : Cet article rapporte la amélioration de terrain et la excavation d'un passage au travers entre deux tunnels bouclier pour la construction de la Ligne Tu-chen des Systèmes de Transit Rapide de Taipei. La injection a été conduit aux sols autour de la passage au travers avant la machine bouclier à percer. Les essais de fuite d'eau sont été conduit à détecter un éventuel fissure dans la béton-sols de JSG, et la injection chimique a été conduit aux les fissures rimplies a partir de tunnel bouclier. Il est conclut que les conditions de surterrain rencontrées dans les différentes profondeurs peut-être assez compliquées. L'ingénieur de géotéchnique devrait jamais suréstimer les caractéristiques de étanchéité de béton-sols formés autour de la passage au travers par la injection chimique. Sous la menace de haut pression d'eau, l'entrepreneur est suggéré de s'apporter le concept de multiple-défense-lignes à garder le travail d'excavation dans un bon côté.

KEYWORDS: cross passage; jet grouting; ground improvement; tunnel; water leak test.

1 INTRODUCTION

The mass rapid transit (MRT) system is one of the most efficient transportation methods in metropolitan areas. However, the densely-populated traffic movements are restricted in a small and close environment. In case of an emergency, such as a fire in an underground tunnel, it might be very difficult for the passengers to evacuate and could easily cause exceedingly heavy casualties and loss of lives.

The National Fire Protection Association (NFPA) required that, to minimize the damage, cross passages between the MRT main tunnels should be constructed for safety and evacuation

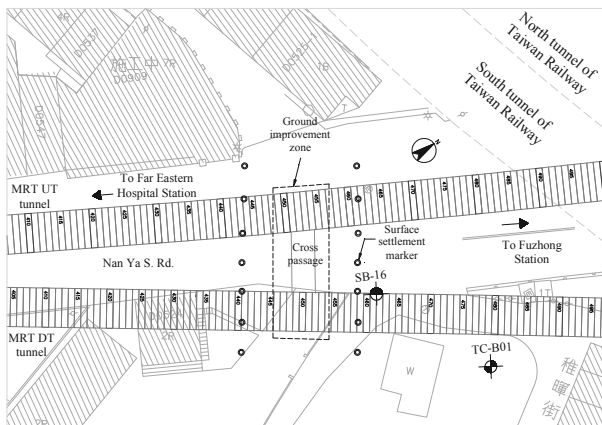

Figure 1. Location of MRT tunnels and cross passage.

reasons. In the design and construction of Taipei MRT, Kaohsiung MRT and Taoyuan International Airport MRT in Taiwan, a cross passage must be fabricated for every 250 to 500 m of single-circular double-tube tunnels.

It should be noted that the excavation of an underground cross passage is a highly risky operation and many associated accidents were reported in the literature. Under the threat of high water and earth pressure, an opening have to be cut on the steel lining segment of the completed main tunnel. The excavation of the cross passage was carried out under the indefinite protection of the improved ground, steel supports and assembled steel segments. In case of an accident during the excavation of the cross passage, the groundwater and soils might flow into the excavation zone, causing large amounts of ground loss, and induce excessive ground movements which might damage the completed main tunnels. In this paper, the ground improvement and construction of the cross passage for lot CD266 of Taipei MRT is introduced.

2 GROUND IMPROVEMENT FOR CROSS PASSAGE

2.1 Project description

Construction lot CD266 of the Tu-chen Line of Taipei MRT included the Far Eastern Hospital station, Fuzhong station, and two sections of shield tunnels. In Figure 1, the cross passage between two MRT tunnels is located on the Nan Ya South Road, in the south-west of the lacustrine Taipei basin. Based on the data from boring SB-16 (Sinotech Engineering Consultants,

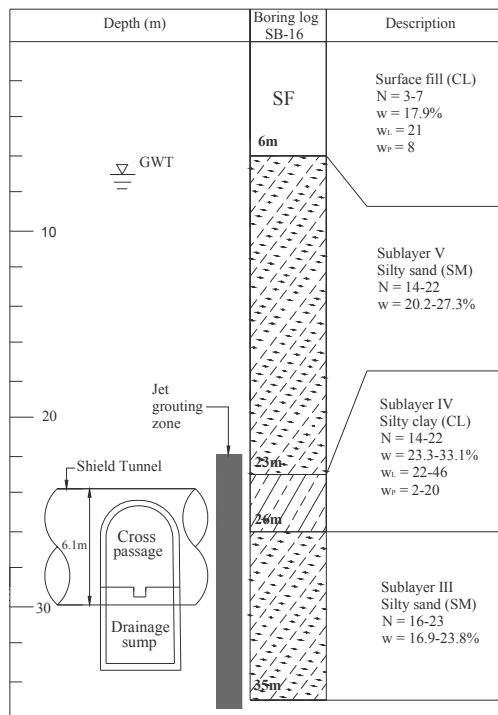

Figure 2. Geological profile for excavation of cross passage and drainage sump. (after Continental Engineering Corp., 2003)

1992), Figure 2 shows the geological profile adjacent to the cross passage. In the figure, the groundwater table was at about 7 m below ground level.

Figure 2 shows the cross passage was constructed at the depth of 24.7 to 29.3 m. Plus the 4.4 m-deep drainage sump, the excavation was extended to the depth of 33.7 m. Soils excavated for the cross passage included silty clay (classified as CL) and silty sand (classified as SM). Engineering properties of these soil deposits, such as the natural water content w , standard penetration test blow count N , liquid limit w_L and plastic limit w_P were indicated in Figure 2.

JSG (Jumbo Special Grout) operation was completed before the shield machine arrived. Based on the size of the cross passage and the recommendations of the Jet Grout Technical Information (JJGA 1990), the grouting zone was 13.5 m-high, and 8.2 to 23.5 m-wide as illustrated in Figure 3. Figure 4 shows a total of 168 1.4 m-diameter JSG piles were fabricated.

2.2 JSG operation and quality control

The technique of JSG utilizes high-pressure water-cement jet streams (sheathed with air pressure) to cut, replace and mix with native soils. For every 1 m³ of jet grout, 600 kg of type I Portland cement was mixed with 0.81 m³ of water. The jetting pressure was controlled at 19.6 MPa (200 kgf/cm²), and the rate of flow was 0.06 m³/min. The air pressure used was 0.6 to 0.7 MPa (6 to 7 kgf/cm²). The grouting rod was controlled to rotate at 6 to 7 r.p.m., and to uplift at the speed of 2.0 m/hr.

After ground improvement, soilcrete cores were drilled and field permeability tests were carried out. The minimum core recovery of 80% and the maximum coefficient of permeability of 1×10^{-7} m/s were required for the improved body. 28 days after grouting, the design specification requires the uniaxial compressive strength of sample obtained from sandy and clayey layer should reach at least 2.94 MPa (30 kgf/cm²) and 0.98 MPa (10 kgf/cm²), respectively. For more information regarding the JSG application for the construction of Taipei MRT, the reader is referred to Fang and Chung (1997), Fang and Yu (1998), and

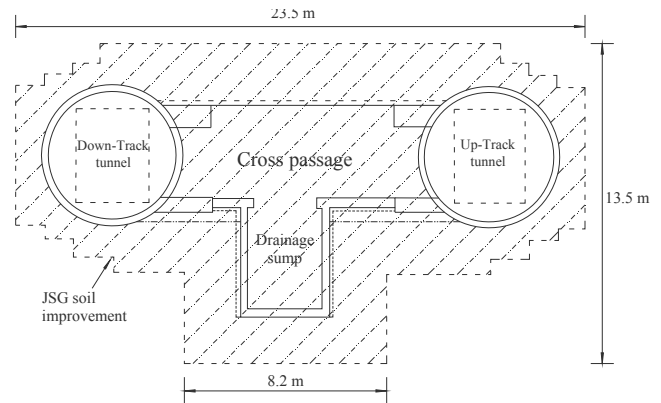

Figure 3. Section of JSG ground improvement for cross passage.

Fang et al. (1993, 1994a, 1994b).

3 CONSTRUCTION OF CROSS PASSAGE

3.1 Preparation

Due to the pushing, cutting and disturbing of the cutter disc of the EPB shield tunneling machine, cracks and discontinuities in the improved ground might be induced. As a result, the water-leak test on the jet-grouted body became necessary. Figure 5 shows holes were drilled from the tunnel to the soilcrete to investigate the quality of ground modification. The holes should not penetrate the improved ground as to create new intruding paths for groundwater. When a significant amount of water-leak was measured in the tunnel (see Figure 6), additional chemical grouting was conducted as indicated in Figure 7. Low pressure grout with a mixture of water-glass and SL reaction agent was injected to the improved ground to seal all water paths around the cross passage.

To repress the inflow of groundwater at the face of excavation, and to increase the safety of construction, the compressed-air method was employed. The air-lock used is shown in Figure 8. For most of the working days, the air pressure was kept at 60 to 80 kPa, and the maximum air pressure used was about 180 kPa.

For the mining of the cross passage, circular holes were cut on the steel segments of the main MRT tunnels. The load release on the opening would cause a redistribution of pressure on the tunnel lining, and a possible stress concentration on adjacent lining segments. For this reason, Figure 9 shows the contractor fabricated octagonal steel reinforcements on both sides of the opening in the tunnel for protection.

3.2 Excavation

The excavation of cross passage was conducted manually. The digging was divided into four parts: (1) top heading (the upper part); (2) bench (the middle part); (3) invert (the lower part);

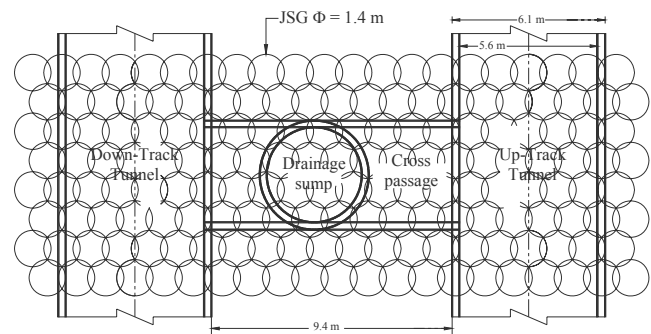

Figure 4. Plan of JSG ground improvement for cross passage.

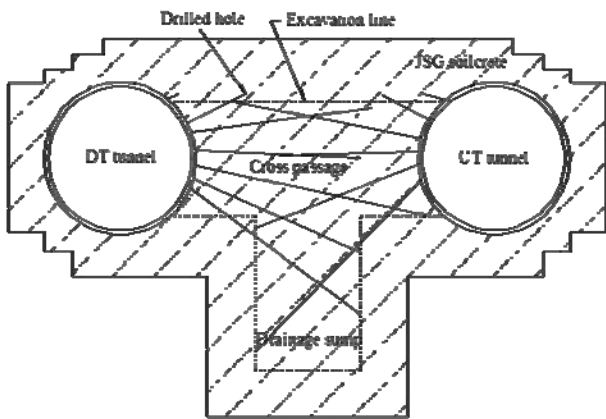

Figure 5. Holes drilled for water-leak test.

and (4) drainage sump. For every 0.5 m of top heading mining, the top part was supported by the assembled steel lining-segments. The void between the improved ground the segment was backfilled to prevent any segment movement.

For every 0.5 m of downward digging for the drainage sump, the shaft was supported with an assembled steel segment ring, and the void behind the ring was backfilled with grouting materials. Even with the JSG grouting, additional chemical grouting, and water-leak test, small amount of groundwater seep-in was observed in the unlined drainage sump. With the help of compressed-air, the amount of groundwater seep-in was minimized and pumped out of the sump before lining. Lot CD266 of Taipei MRT was completed and started to operate on May 31 of 2006.

It should be noted that the soil and groundwater conditions encountered below the depth of 30 m could be quite complicated. The geotechnical engineer should never overestimate the effects of jet grouting and chemical grouting. Under the threat of the tremendous groundwater pressure, to keep the construction on the safe side, it is suggested to maintain a cautious attitude and take conservative measures.

4 MULTIPLE LINES OF DEFENSE

For Lot CD266 of Taipei MRT, the groundwater table was located at about 7.0 m below ground level. The bottom of the drainage sump was located at the depth of 33.7 m, at which the excavation zone must be able to resist 26.7 m of pressure head. Under the challenge of this immense groundwater pressure, any micro-crack in the improved ground might cause water and soil to stream into the excavation zone; carry away ground materials near the cross passage, damage the completed main tunnels, and



Figure 6. Water-leak test before cross passage excavation.

result in exceedingly serious consequences. When facing such potential hazards, to reduce the risk of construction, the designer is suggested to adopt the following “Multiple Lines of Defense” strategy.

4.1 First line of defense - jet grouting

For this project, the first line of defense for the excavation of cross passage is the JSG ground improvement. The diameter of the jet-grouted pile was assumed to be 1.4 m. However, the actual JSG pile diameter at the depth of 35 m was hard to justify. Besides, the grouting rod was assumed to be totally vertical. Any slight tilting of the grout rod from verticality may cause the bottom of the soilcrete pile to deviate laterally. The resulting discontinuity of the improved ground could create a path for the invading groundwater.

4.2 Second line of defense – water-leak test and chemical grouting

The disturbance of improved ground by the boring of the shield machine might create new cracks and fissures in the soilcrete body. For this project, the water-leak test and the following additional chemical grouting served as the second line of defense.

4.3 Third line of defense – compressed air

If the first and second defense lines were insufficient to resist the groundwater inflow driven by the tremendous pressure head, the compressed air method was used as the third line of defense. The compressed air was an effective measure to repress the seep-in of groundwater in the excavation face of the drainage sump.

4.4 Fourth line of defense – safety gates

In case the jet grouting, leak-test and addition grouting, and compressed air methods all failed to resist the invasion of the groundwater, the fourth defense line could be activated. This simple and effective method is to fabricate three steel gates at the top of the drainage sump, and at both ends of the cross passage (see Figure 10). If the break in of groundwater appears irresistible, in the worst case scenario, the tunneling crew could simply shut the emergency gates. The flow of groundwater and loss of ground will be confined in a small and restricted zone. The contractor should never be overconfident as to give up this last line of defense.

5 CONCLUSIONS

In this paper, the ground improvement and construction of



Figure 7. Additional chemical grouting in tunnel before cross passage excavation.

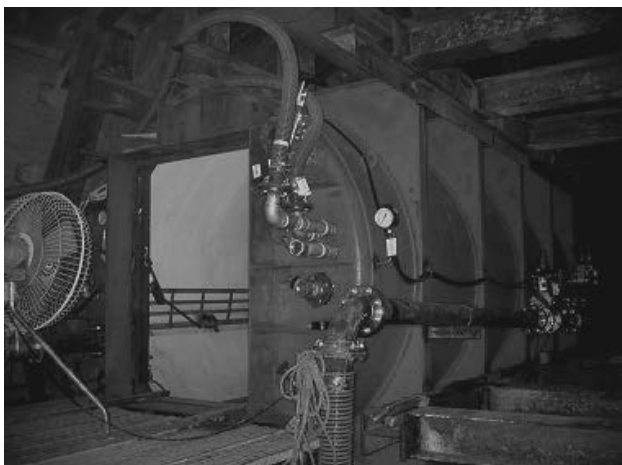

Figure 8. Air-lock of compressed-air operation for cross passage excavation.



Figure 9. Octagonal steel-beam reinforcement inside tunnel.

cross passage for lot CD266 of Taipei MRT is introduced. For this project, the excavation zone at the bottom of the drainage sump must be able to resist 26.7 m of pressure head. Under the challenge of this immense groundwater pressure, any crack in the improved ground might cause water and soil to flow into the excavation zone; carry away ground materials near the cross passage, damage the completed main tunnels, and result in exceedingly serious consequences.

It should be noted that the ground conditions encountered at great depths could be quite complicated. The geotechnical

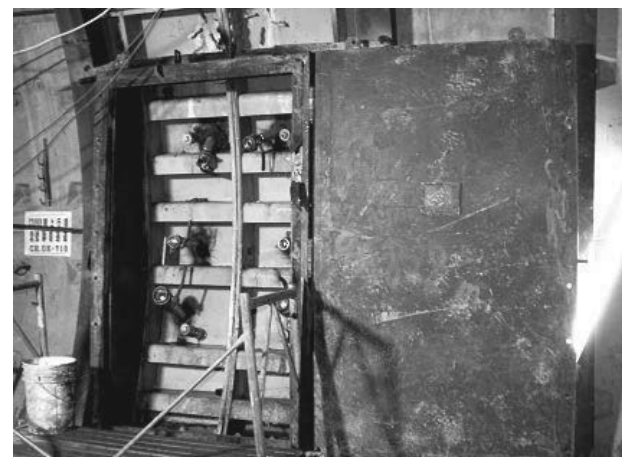

Figure 10. Steel safety-gates at the end of cross passage.

engineer should never overestimate the effects of jet grouting and chemical grouting. Under the threat of the tremendous groundwater pressure, to keep the construction on the safe side, it is suggested to maintain a cautious attitude and take conservative measures. When facing potential underground hazards, to reduce the risk of construction, the designer is suggested to adopt the “Multiple Lines of Defense” concept.

6 ACKNOWLEDGEMENTS

The authors wish to thank the Central District Project Office, Department of Rapid Transit Systems, Taipei City Government, for providing valuable information and support. The kind assistance of Sinotech Engineering Consultants, Ltd. is also gratefully acknowledged.

7 REFERENCES

- Continental Engineering Corp. 2003. Taipei metropolitan area MRT systems, Tu-chen Line construction lot CD266, construction proposal for cross passage and drainage sump. (in Chinese)
- Fang, Y.S. and Chung, Y.C. 1997. Jet grouting for shield tunneling in Taipei. Proc. Int. Conf. on Ground Improvement Techniques, Macau, 189-196.
- Fang, Y.S. and Yu, F.J. 1998. Engineering properties of jet-grouted soilcrete and slime. Keynote Speech, Proc. Int. Symp. on Jet Grouting, Singapore, 589-596.
- Fang, Y.S., Liao, J.J. and Lin, T.K. 1994a. Mechanical properties of jet grouted soilcrete. Quarterly Journal of Engineering Geology, 27(3), 257-265.
- Fang, Y.S., Liao, J.J. and Sze, S.C. 1994b. An empirical strength criterion for jet grouted soilcrete. Engineering Geology, 37(3-4), 285-293.
- Fang, Y.S., Yang, J.S. and Sze, S.C. 1993. Strength and permeability of jet grouted soilcrete for Taipei MRT construction. Proc. 11th Southeast Asian Geotech. Conf., Singapore, 337-342.
- Japanese Jet Grouting Association. 1990. Jet grout technical information. 2nd Edition, Tokyo, Japan. (in Japanese)
- Sinotech Engineering Consultants, Ltd. 1992. Taipei metropolitan area MRT systems, Tu-chen Line design lot DD188, geological exploration and soil testing report. (in Chinese)