

Model tests on settlement behaviour of ballasts subjected to sand intrusion and tie tamping application

Tests de modélisation sur le comportement en tassement des ballasts sujets à l'intrusion de sable et au bourrage

Kumara J., Hayano K.
Yokohama National University

ABSTRACT: Effects of sand intrusion into ballast (i.e., ballast fouling) and tie tamping application on settlement characteristics of ballasted trail track were investigated by series of model tests with cyclic loading. Model tests were conducted on 1/5th scale of the actual size of railway track. Ballast fouling was simulated by sand-gravel mixtures (i.e., gap graded particle size distribution). Tie tamping application was physically simulated in the model tests using a simple tool. The relationship of number of loading cycles and settlement was obtained and results were discussed with degree of ballast fouling (i.e., amount of sand in sand-gravel mixtures). The results indicated that initial settlement process and rate of residual settlement alter after 30% sand. Initial settlement period is higher for fouled ballast with 30% or more sand after tie tamping application. Rate of residual settlement is higher for fouled ballast with more than 30% sand after tie tamping application. That's to say, tie tamping application is effective for fouled ballast up to 30% fines.

RÉSUMÉ : Les effets de l'intrusion de sable dans le ballast et du compactage par bourrage du ballast sur le comportement en tassement des voies ferrées ballastées ont été étudiés en effectuant une série d'essais cycliques de chargement sur des échantillons tests. Les tests ont été réalisés sur modèle à une échelle d'un cinquième, et l'exécution du bourrage a été physiquement simulée dans les essais à l'aide d'un outil simple. La relation entre le nombre de cycles de chargement et le tassement a été obtenue et les résultats en fonction du degré d'intrusion de sable et du compactage ont été étudiés. Les résultats indiquent que le processus de tassement initial et le taux de tassement résiduel sont modifiés au delà de 30% d'intrusion de sable. Le taux de tassement résiduel est plus élevé pour le ballast bourré et compacté comportant plus de 30% de sable, ce qui revient à dire que le compactage pour le ballast bourré est effectif jusqu'à 30% de fines.

KEYWORDS: Ballast fouling, ballasted railway track, model test, residual settlement, tie tamping application.

1 INTRODUCTION

In railway tracks, ballast fouling occurs when fine materials mix with ballast due to heavy repeated train loads. Generally, fine materials come mainly from underneath layers, and to a lesser extent, due to particle crushing too (Indraratna et al., 2004). Sand intrusion alters the original particle size distribution (PSD) of ballast, resulting different settlement characteristics than that of fresh ballast. Once the settlement reaches the allowable limit, a maintenance method should be implemented to bring the railway track into the original position. Usually, tie tamping application is used worldwide as the main maintenance method. However, effects of ballast fouling on settlement characteristics and tie tamping application itself haven't been well understood in the past.

In this study, effects of degree of ballast fouling and tie tamping application on settlement characteristics of ballasted tracks were investigated. A series of cyclic loading tests were conducted on a model sleeper of 1/5th scale of the actual rail track as shown in Figure 1. In the model tests, tie tamping application was physically simulated by inserting a small tool into the ballasts.

2 MODEL GROUNDS AND CYCLIC LOADING

Figure 1 shows the model test apparatus used in this research. Model grounds at a scale of 1/5th were constructed in a sand box with interior dimensions of 800mm wide, 304mm deep, and 300mm high. A duralumin footing with a width of 48mm was used to model the sleeper. Gravel approximately 1/5th of the size of actual ballasts were selected to model the ballasts. Medium size sand (M sand) was used as sand. PSDs of gravel and M sand are shown in Figure 2.

The model tests were conducted on fouled ballast (i.e., 5 cases) and fresh ballast as given in Table 1. Ballast thickness was made as 50mm (i.e., 1/5 of 250mm of actual ballast layer) in each case and 100 loading cycles were applied before tie tamping application. Cyclic loadings were applied to the model grounds through the sleeper at a constant displacement rate of 0.05mm/s. The amplitude of the cyclic stress applied was 120kN/m² (i.e., approximately 70% of maximum stress M sand can withstand). All the specimens were prepared with 80% of relative density, D_r . How void ratios, e_{max} and e_{min} of fresh ballast (i.e., gravel) change with amount of sand mixed can be seen in Figure 3.

Tie tamping application was simulated with the tool shown in Figure 3. First, the sleeper was lifted to the initial position after 100 loading cycles were applied. Next, a small spoon was inserted (e.g., about 8-10mm) into the model ground by sides of the sleeper. After the spoon reached the fixed ground depth (i.e., 8-10mm), it was tilted several times to permit the particles to move laterally. This procedure was followed at several locations until the voids between the sleeper and the ground surface were completely filled by the particles. Finally, additional gravels (except in case 6 where M sand was used) were introduced to the ground surface near the sleeper to produce a flat ground surface. After this tie tamping application, 100 loading cycles were applied again. Axial displacement was measured using two displacement transducers, placed at the front and back of the sleeper.

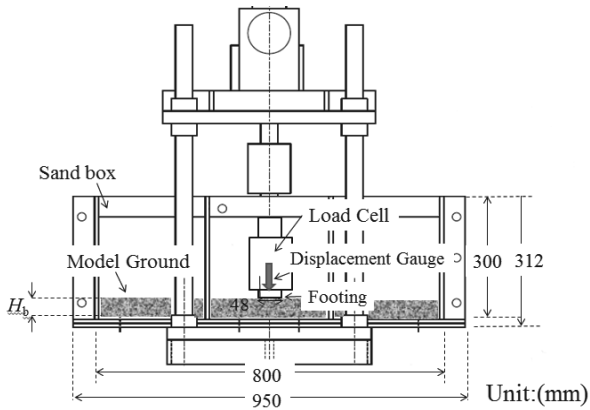

Figure 1. Model test apparatus for model test

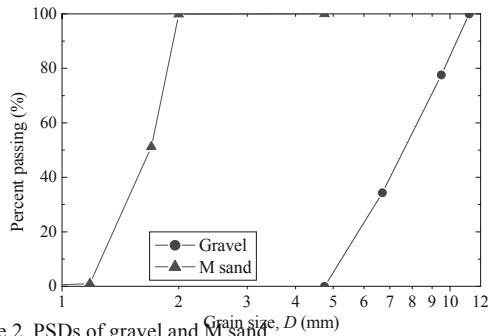

Figure 2. PSDs of gravel and M sand

Table 1. Model test conditions

Case No	% sand	Dry density, ρ (kg/m ³)	Relative density, D_r (%)
1	0	1519	80
2	15	1698	80
3	30	1829	80
4	50	1929	80
5	70	1788	80
6	100	1684	80

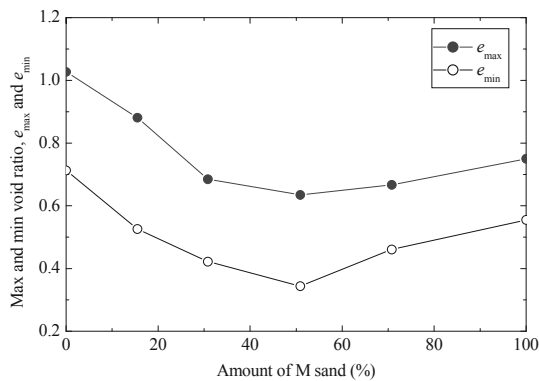

Figure 3. Max and min void ratios vs. % sand (Kumara et al., 2012)

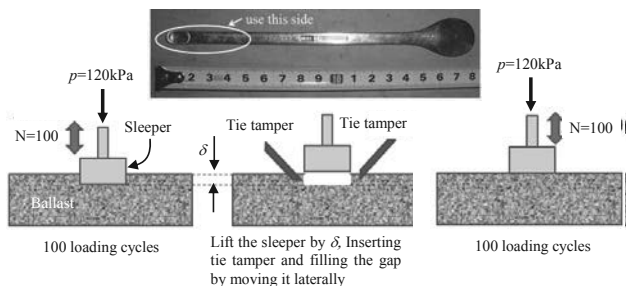

Figure 4. The tool and procedure used for simulating tie tamping application

3 RESULTS

3.1 Effects of PSDs on settlement characteristics

Figures 5 and 6 show the results of settlement, S with no. of loading cycles, N for fresh ballast (i.e., gravel) and fouled ballast (i.e., 15, 30, 50, 70% and 100% sand) cases before and after tie tamping application respectively. It clearly shows that fouled ballast alters the settlement characteristics of fresh ballast significantly, both before and after tie tamping application. As shown in Figures 5 and 6, the smallest settlement was observed in cases of 30 and 50% sand specimens. The smallest settlement observed for 30 and 50% sand cases can be understood from the results of void ratios, e_{max} and e_{min} with % sand as shown in Figure 3 where it shows minimum values of void ratios were observed for the mixtures with 30-50% sand.

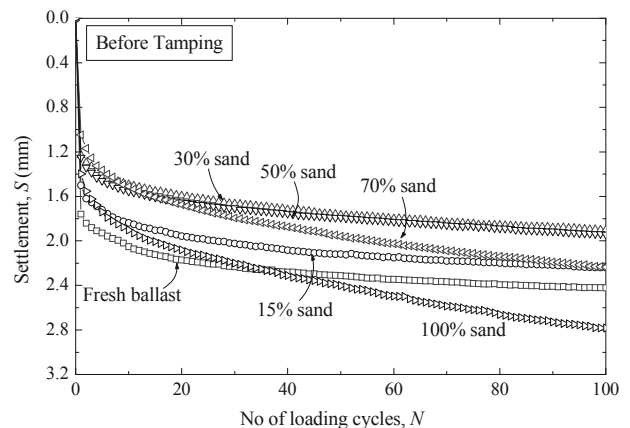

Figure 5. Relationships between no. of loading cycles and settlement before tie tamping application

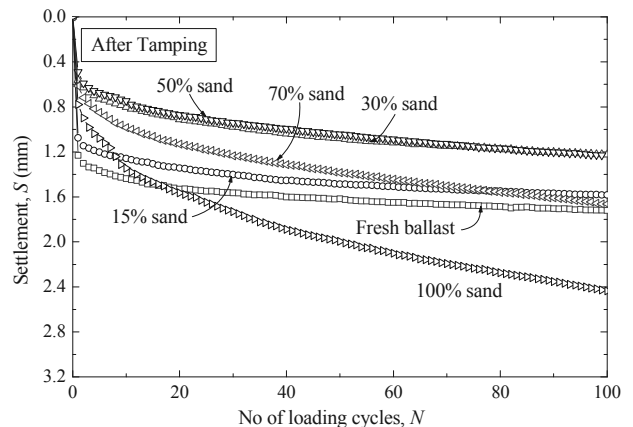

Figure 6. Relationships between no. of loading cycles and settlement after tie tamping application

Figure 7 shows the results of settlement at 100th loading cycle, S_{100} vs. %sand for all the tests and clearly indicates how PSDs affect settlement both before and after tie tamping application. The relationship is quite similar to e_{max} and e_{min} relationships with % sand (Figure 3).

The relationships between no. of loading cycles, N and sleeper settlement, S were obtained using Eq. 1 (Sekine et al., 2005),

$$S = c(1 - e^{-\alpha N}) + \beta N \quad (1)$$

where c and α represent the initial settlement process, and β represents the process of residual settlement. The relationships for fresh ballast (i.e., gravel) and 30% sand cases are shown in Figure 8.

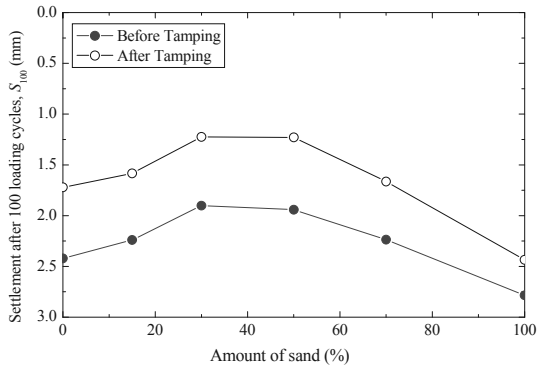

Figure 7. The settlement at 100 loading cycle vs. % sand

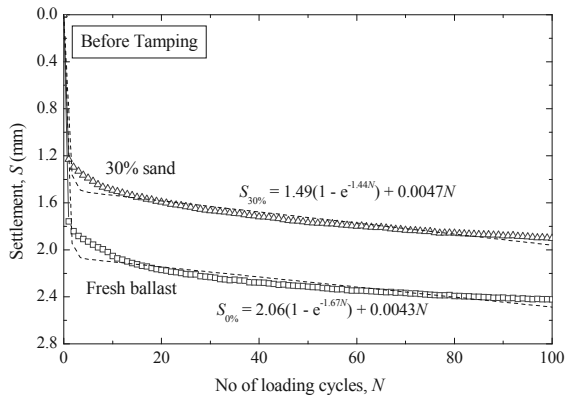

Figure 8. Relationships between S and N for fresh ballast and 30% sand cases (before tie tamping application)

3.2 Effects of roadbed stiffness on settlement characteristics

Figure 9 shows typical relationships between sleeper settlement and applied stress, p (30% sand case is shown here). It can clearly be seen that settlement reduces in the 2nd phase (i.e., after tie tamping application), due to densification of the specimen in the 1st phase (i.e., before tie tamping application with 100 loading cycles).

In this research, the loading curves were fitted by bilinear lines, and the slopes of the two lines were estimated as k_1 and k_2 as shown in Figure 10. Displacement u_2 was estimated by dividing the applied stress by k_2 as shown in Figure 10. The parameter u_2 decreases and tends to show a constant value with N as shown in Figure 11. Therefore, these constant values were used in the following discussion.

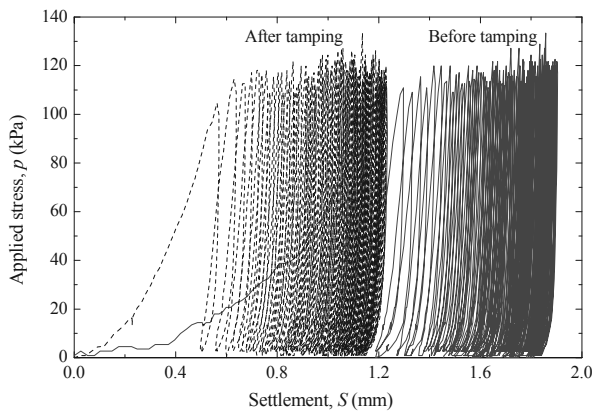

Figure 9. Applied stress vs. settlement for 30% sand case

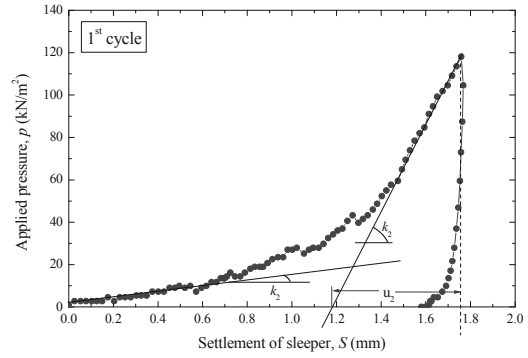

Figure 10. Calculation of u_2 (Gravel specimen)

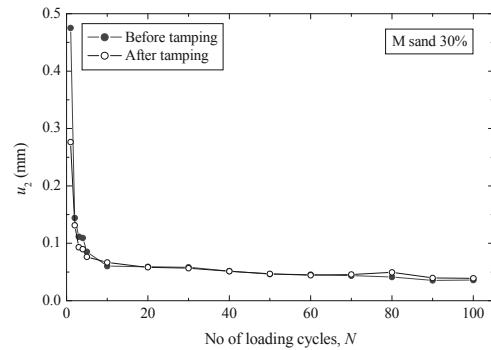

Figure 11. Relationships of u_2 and N (30% sand case)

The relationships between u_2 with %sand, c , α and β before and after tie tamping application are shown in Figures 12-15 respectively. Figure 12 shows that 50% sand specimen is the densest specimen (i.e., showing the smallest u_2). Figure 13 shows that c increases with u_2 (though not very clearly), indicating that loose specimen will result in higher initial settlement, in both before and after tie tamping application. Figure 14 shows that initial settlement period alter by tie tamping application with a wider gap between the highest and smallest α compared to those of before tie tamping application.

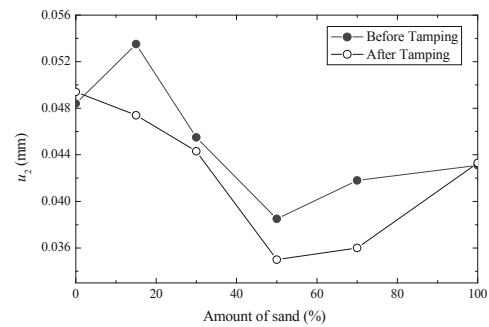

Figure 12. Relationships of u_2 and % sand

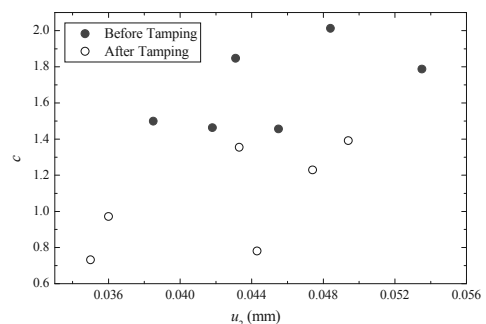

Figure 13. Relationships of u_2 and c

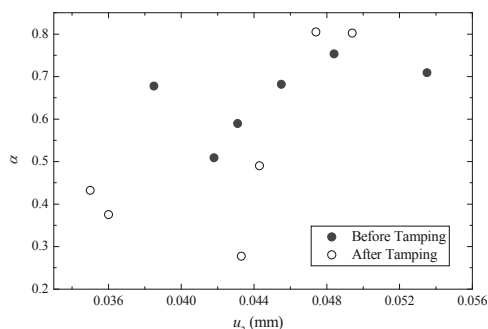

Figure 14. Relationships of u_2 and α

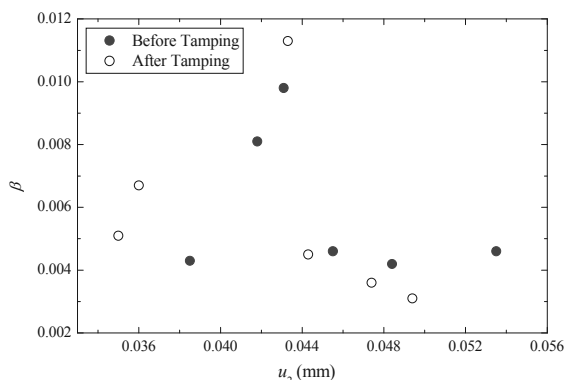

Figure 15. Relationships of u_2 and β

3.3 Effects of tie tamping application on settlement characteristics

Figures 16-18 show how c , α and β change with %sand. Figure 16 shows that c , parameter indicating initial settlement amount, reduces until 30-50% sand and then increases, almost same as how e_{max} and e_{min} change with %sand (Figure 3). While α , parameter indicating period of initial settlement process, reduces with %sand, β , parameter indicating rate of residual settlement, increase with %sand. The results of α can be interpreted as initial settlement period increases with degree of fouled ballast (i.e., increasing of %sand). The results of β can be interpreted as rate of residual settlement increases with degree of fouled ballast (i.e., increasing of %sand).

As shown in Figure 16, c reduces with %sand up to 30-50% and then increases. This tendency is same for both before and after tie tamping application. However, change of α with %sand is more after tie tamping application for the specimens with more than 15% sand. That's, initial settlement period increases significantly with %sand after tie tamping application (Figure 17). The results also showed that rate of residual settlement is higher after tie tamping application for the specimens with more than 30% sand (Figure 18). That's, tie tamping application seems effective for fouled ballast mixed with up to 30% fines.

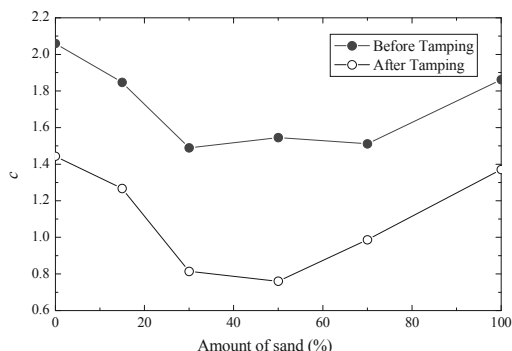

Figure 16. Relationships of c and % sand

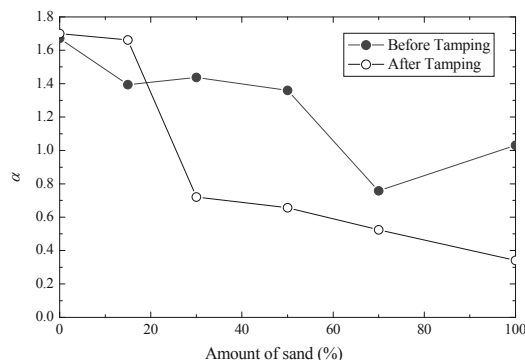

Figure 17. Relationships of α and % sand

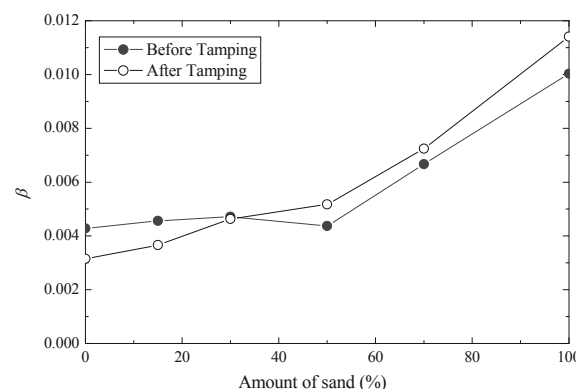

Figure 18. Relationships of β and % sand

4 CONCLUSIONS

The effects of sand intrusion into ballast and tie tamping application on settlement characteristics were investigated using series of cyclic loading model tests. The following conclusions were derived from this research:

- (1) The characteristics of the initial settlement process are altered considerably after tie tamping application; especially if ballast is mixed by more than 30% fine materials.
- (2) Rate of residual settlement increases after tie tamping application if ballast is mixed by more than 30% fine materials. Therefore, tie tamping application seems effective for fouled ballast with less than 30% fines.

5 ACKNOWLEDGEMENTS

Japanese Government is acknowledged for providing financial assistance to the first author to study in Yokohama National University, Japan through a Monbukagakusho scholarship.

6 REFERENCES

- Indraratna B., Shahin M., Rujikiatkamjorn C. and Christie D. 2004. Stabilisation of ballasted rail tracks and underlying soft formation soils with geosynthetic grids and drains. GeoShanghai International Conference, Shanghai, China, June 2-4, 2006.
- Kumara G.H.A.J.J., Hayano K., Ogiwara K. and Takeuchi M. 2012. Fundamental study on the simple evaluation methods for particle size distribution and maximum/minimum void ratio of sand-gravel mixtures, 2nd International Conference on Transportation Geotechnics, Hokkaido, Japan, 572-577, September 10-12, 2012.
- Sekine E., Ishikawa T. and Kouno A. 2005. Effect of ballast thickness on cyclic plastic deformation of ballasted track, RTRI Report, 19 (2), 17-22 (in Japanese).